

**BEISIT**®

倍仕得电气科技(杭州)股份有限公司  
BEISIT ELECTRIC TECH (HANGZHOU) CO.,LTD.



## BLIND MATING TYPE Fluid Connector 盲插式流体连接器

HANGZHOU • CHINA

名称牌号		材料特性	表面处理
黄铜	HPb59-1	HPb59-1是应用较广的铅黄铜，可切削性好，有良好的力学性能，能承受冷、热压力加工，易纤维焊和焊接，对一般腐蚀有良好的稳定性，但有腐蚀破裂倾向。	电镀：利用电源能将镍阳离子转换成金属镍沉积到阳极上；黄铜镀镍是利用化学还原的方法，将镍阳离子还原成金属镍并沉积在基体（黄铜）表面上，赋予制品特殊的表面性能。例如：赋予制品多种色彩、较强的耐腐蚀性 / 耐磨性，镀层结晶细致、平滑光亮、内应力小，导电性能极佳。 化学电镀：采用金属盐和还原剂，在材料表面上发生自催化反应获得镀层；黄铜镀镍是利用还原剂在活化零件（黄铜）表面上自催化还原沉积得到镀层化学镀镍制品的主要特点是：镀层厚度均匀，致密性好、镀层附着力强、深度能力强、抗腐蚀能力好
	H62	在黄铜中加 1% 锡能显著改善铜的抗海水和海洋大气腐蚀的能力，因此称为海军黄铜；锡黄铜在海水中有着高的耐腐蚀性，有良好的力学性能，可切削性好，易焊接和纤维焊。	
铝	6061-T6	具有加工性能极佳、优良的焊接特点及电镀性、良好的抗腐蚀性、韧性高及加工后不变形、材料致密无缺陷及易于抛光、上色膜容易、氧化效果极佳等优良特点。	阳极氧化：以铝作为阳极，置于电解质溶液中进行通电处理，使其表面形成氧化铝薄膜。铝阳极氧化的主要特点是：改善耐腐蚀性、提高表面硬度和耐磨性、具有良好的装饰性能。
不锈钢	316	因添加钼，故其耐蚀性、耐大气腐蚀性和高温强度特别好，可在苛酷的条件下适用；加工硬化性优（无磁性）。	钝化处理：与钝化剂反应形成一层稳定的钝化膜，从而保护不锈钢基材不被氧化腐蚀导致生锈，大大延缓不锈钢的腐蚀速度。

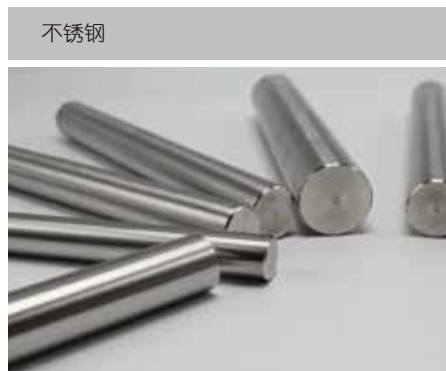

Material brand no.		Material Characteristics	Surface treatment
<b>Brass</b>	HPb59-1	HPb59-1 is a widely used lead brass with good machinability and good mechanical properties. It can withstand cold and hot pressure processing, is easy to wire and weld, and has good stability to general corrosion, but it has corrosion cracking tendency.	<p>1. The electroplating is a process that uses electric current to transform Nickel cation into metal nickel deposition on the anode; Nickel-plated brass is a process that uses chemical reduction to reduce Nickel cations into metal nickel deposition on the surface of the substrate (brass), giving the special surface properties to the products. For example: giving products a variety of colors, strong corrosion resistance/wear resistance, exquisite crystallization on coating, smooth and bright, small internal stress and good electroconductivity.</p> <p>2. The electroless plating is a process that uses metal-salt and reducing agent to produce autocatalytic reaction on the material surface in order to obtain coating; Nickel-plated brass is a process that uses reducing agent to produce autocatalytic reduction deposition on activation parts (brass) surface in order to obtain coating. The main Properties of electroless nickel plated products are: well-distributed coating thickness, good compactness, coating adhesion, and plating depth capability, good corrosion resistance.</p>
	H62	Adding 1% tin in brass can significantly improve the ability of copper to resist the corrosion of seawater and ocean atmosphere, so it is called navy brass; tin brass has high corrosion resistance in seawater, has good mechanical properties, and good cutability, easy to weld and fiber weld.	
<b>Aluminium</b>	6061-T6	6061 aluminum has excellent processing performance, excellent welding and electroplating characteristics, good corrosion resistance, high toughness, no deformation after processing, it is a dense material without defects, easy polishing, easy coloring film and good oxidation effects.	Anodic oxidation: Aluminum as an anode, placed in electrolyte solution for electric treatment, aluminum surface formed alumina film. The main characteristics of aluminum anodic oxidation are: improve corrosion resistance, improve surface hardness and wear resistance, with good decorative performance.
<b>Stainless Steel</b>	316	Due to the addition of molybdenum, its corrosion resistance, atmospheric corrosion resistance and high temperature strength are particularly good, and it can be applied under harsh conditions; excellent work hardening (non-magnetic).	Passivation treatment: with passivation agent reaction to form a layer of stable passivation film, so as to protect the stainless steel base material from oxidation corrosion caused by rust, greatly delay the corrosion speed of stainless steel.



名称牌号	材料特性	应用
NBR 丁腈橡胶	丁腈橡胶是由丁二烯和丙烯腈经乳液聚合得的，丁腈橡胶主要采用低温乳液聚合法生产，耐油性极好，耐磨性较高，耐热性较好，粘接力强。其缺点是耐低温性差、耐臭氧性差，电性能低劣，弹性稍低。	丁腈橡胶主要用于制作耐油制品，如耐油管、胶带等。常用于制作各类耐油模压制品，如O形圈、油封、也用于制作胶板和耐磨零件。
EPDM 三元乙丙橡胶	三元乙丙橡胶最主要的特性就是其优越的耐氧化、抗臭氧和抗侵蚀的能力。耐老化性能非常好，耐气候性好，电绝缘性能优良，耐化学腐蚀性好，冲击弹性较好。	主要应用于要求耐老化、耐水、耐腐蚀、电气绝缘的领域如用于轮胎的浅色胎侧、汽车内胎、电缆、电线、门窗密封条、家用电器配件等。
硅橡胶	1.高温性能：在 200℃以上的高温环境下，硅橡胶仍能保持一定的柔韧性、回弹性和表面硬度，且力学性能无明显变化。 2.低温性能：硅橡胶的玻璃化温度为-70~-50℃，特殊配方可达到-100℃。 3.电气性能：硅橡胶具有优异的绝缘性能，耐电晕性和耐电弧性好。 4.物理机械性能：硅橡胶常温下的物理机械性能比通用橡胶差，但在 150℃的高温-50℃的低温下，其物理机械性能优于通用橡胶。 5.耐油及化学试剂性：普通硅橡胶具有中等的耐油、耐溶剂性能。	硅橡胶密封件在极限温度及压力下，有良好的适用性。
氟橡胶	1.化学稳定性：氟橡胶具有高度的化学稳定性。26型氟橡胶耐石油基油类、双酯类油、硅醚类油、硅酸类油，耐无机酸，耐多数的有机、无机溶剂、药品等。 2.耐高温性优异：氟橡胶的耐高温性能和硅橡胶一样，26型氟橡胶在 250℃下可长期使用。 3.耐老化性能好：26型氟橡胶具有极好的耐天候老化性能，耐臭氧性能。在自然存放十年之后性能仍然令人满意。 4.真空性能极佳：26型氟橡胶具有极好的真空性能。 5.机械性能优良：26型氟橡胶在高温下的压缩永久变形小，在 150℃下的同等时间的压缩永久变形来比较，丁腈橡胶和氯丁橡胶均比26型氟橡胶要大。 6.透气性小：26型氟橡胶在30℃下对于氧、氮、氨、二氧化碳气体的透气性和丁腈橡胶相当，比氯丁橡胶要好。	垫圈使用：能耐油并酸气，胺基类化合物等多种高浓度强腐蚀性介质应用于化工场所，航天航空的控制和燃料系统的航空液压油、喷气燃料、高温润滑油的密封。 应用领域：航天航空、化工、油田、半导体制造。
氟硅橡胶	氟硅橡胶兼有氟素橡胶及硅橡胶的优点，耐油、耐溶剂、耐燃料油及耐高低温性均佳。能抵抗抗氧化化合物、含芳香烃的溶剂及含氮的溶剂的侵蚀。一般使用温度为-50~200℃。	一般用于航空、航天、军事、石油工业、汽车工业及化工等领域。不建议暴露于酮类及刹车油中。

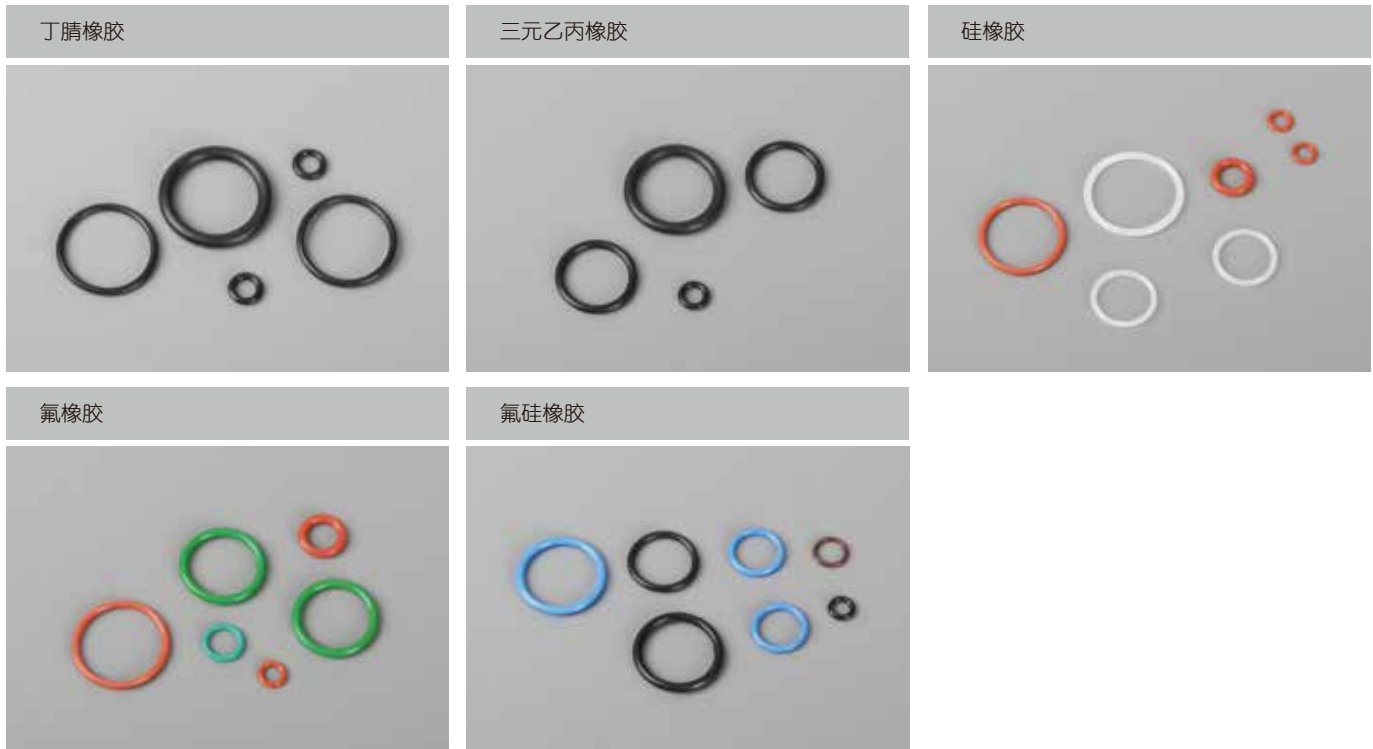

Name	Properties of Materials	Application
<b>NBR</b>	This sealing ring is black with a yellow spot and made from nitrile rubber. It has excellent resistance to petroleum-based fluids. Good physical properties. However, the NBR lip seal should not be used where there is a risk of temperatures above 80°C. NBR is not resistant to solvents, also the flexibility is not good.	NBR is mainly used where there are petrol or oil residues on the waste water (e.g. in connection with oil and petrol separators at service stations, garages etc.), such as O ring, Oil sealing and Rubber panel or other wear-resistance parts.
<b>EPDM</b>	This sealing ring is made of ethylene propene rubber. The general properties of EPDM are excellent ozone, chemical, and aging resistance. It is also known for good resistance to animal and vegetable oils, ozone, strong and oxidizing chemicals.	Mainly used for aging resistance, water resistance, corrosion resistance, electrical insulation fields, such as light colored sidewall for tire, automobile inner tubes, cables, wires, sealing for doors and Windows, appliances and other accessories.
<b>Silicone</b>	<ol style="list-style-type: none"> <li>High temperature: 200 °C high temperature environment, silicone rubber can still maintain a certain degree of flexibility, elasticity and hardness, and no significant changes in mechanical properties.</li> <li>Low temperature: silicone rubber glass transition temperature -70~-50 °C, special formulations could reach -100 degrees centigrade.</li> <li>Electrical performance: silicone rubber has excellent insulating properties, Corona resistance and good arc resistance.</li> <li>Physical and mechanical properties: mechanical properties of silicone rubber is not as good as common rubber at normal temperature. But it's much better than common rubber at 150 °C high temperature and the low temperature of -50.</li> <li>Oil and chemical resistance: ordinary silicone is with moderate oil resistance and solvent resistance.</li> </ol>	Excellent high and low temperature properties. Fair physical properties.
<b>FKM/ FPM/ VITON</b>	<ol style="list-style-type: none"> <li>Chemical stability: FPM has good chemical stability. 26 fluoro rubber resistant to petroleum base oils and diester oils, ether oil, silicon oil silicate, inorganic acid-resistant, resistant to most organic and inorganic solvents, chemicals, etc.</li> <li>Excellent temperature resistance: Just like silicone rubber, 26 FPM can be used for a long time in 250 °C high temperature.</li> <li>26 FPM has excellent resistance to aging, and ozone-resistant properties. The performance remains satisfactory after storage for ten years.</li> <li>26 FPM has excellent vacuum performance.</li> <li>It has good mechanical properties: 26 FPM will deform permanently at under 150 °C Compared with 26 FPM, the deformation of Nitrile rubber and neoprene are larger.</li> <li>Moderate Permeability : Permeability of 26 FPM for oxygen, nitrogen, helium, carbon dioxide gas is nearly same as that of nitrile-butadiene rubber at 30 degree, but better than that neoprene.</li> </ol>	FPM washer is mainly used in oil acid, amino compounds and other places with a high concentration of corrosive media. It is used in the chemical industry, aviation aerospace control and fuel systems hydraulic oil, jet fuel and high temperature lubricating oil sealing. Also used by aerospace, chemical, oil, semiconductor manufacturing.
<b>FVMQ</b>	Fluorine silicone rubber has the advantages of fluorine rubber and silicone rubber, and has excellent oil resistance, solvent resistance, fuel oil resistance and high and low temperature resistance. It can resist the attack of oxygenated compounds, aromatic hydrocarbons and chlorine-containing solvents. The general service temperature is -50~200 .	Generally used in aviation, aerospace, military, petroleum industry, automobile industry, chemical industry and other fields. Exposure to ketones and brake oil is not recommended.

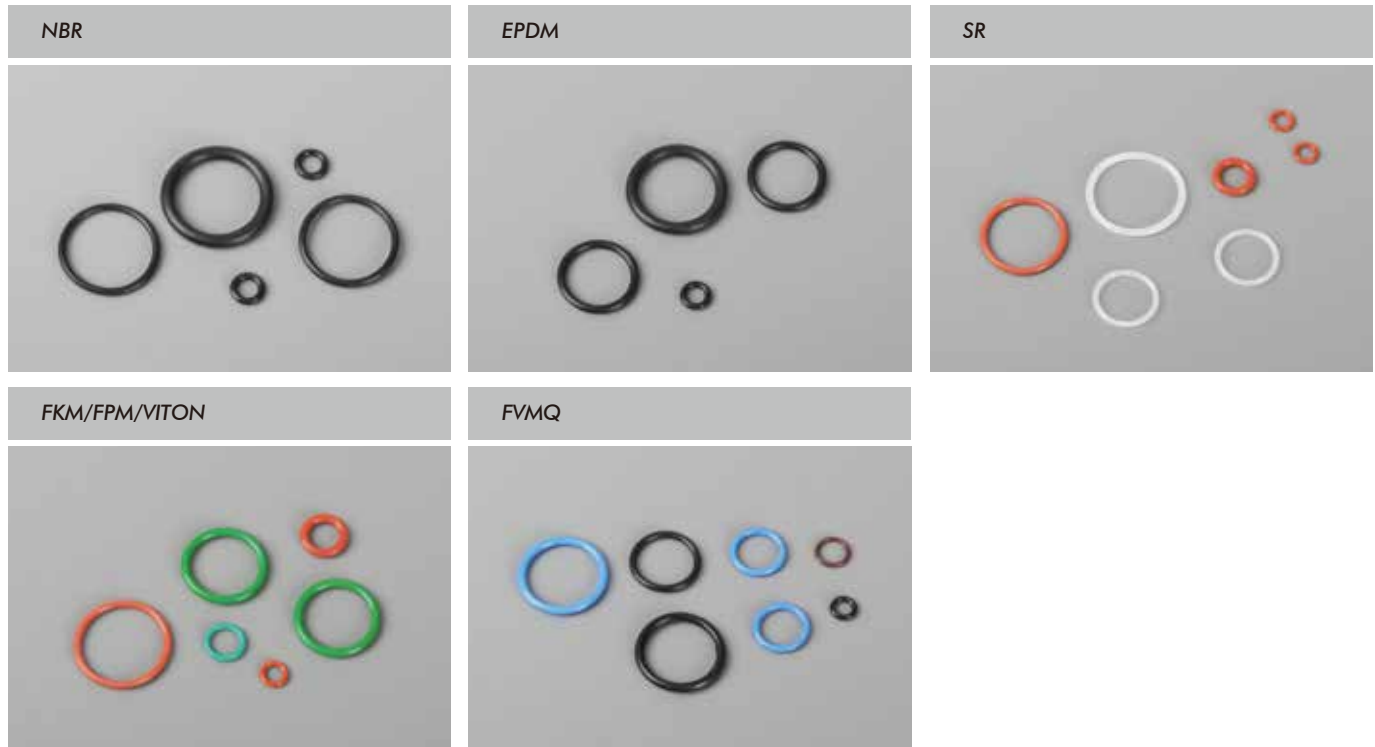

**BI****盲插式流体连接器**

BLIND MATING TYPE Fluid Connector

**应用领域 Application Fields**

- 军工防务、航空航天等领域 Military defense, Aerospace and other fields
- 医疗设备 Medical equipment
- 数据中心、超级计算机 Data center, Supercomputer
- 电子通讯 Electronic communication

**流体 Fluids**

- 冷却液 Coolant
- 水-乙二醇 Glycol Water
- 导热油 Heat transfer oils
- 酯类 Esters
- 煤油 Kerosene

.....



**安全 Safety**

- 双向密封, 接通/断开无泄漏。
- 设备需要过压保护时, 可选自卸压的系列, 避免断开后设备压力过高。
- 工作时, 平头的设计既方便清洁又防止污染物进入。
- 插头插座均配有保护套, 在运输过程中防止污染物进入。
- Two-way sealing, Switch on/off with leakage free.
- Please select pressure release version to avoid high pressure of the equipment after disconnection.
- Flat faced design is easy to clean and prevent contaminants from entering during transportation.
- Protective covers are provided to prevent contaminants from entering during transportation.

**稳定 Stable**

- 优异的流量。
- 高机械寿命, 高插拔次数。
- Excellent flow rate.
- High mechanical life.

**可靠 Reliability**

- 精选的材质配合独特的表面处理使产品坚固可靠的同时, 实现高耐腐蚀性、高耐磨性。
- 有多种密封材质可选, 可兼容各种流体。
- 产品适用温度范围根据不同O型圈可覆盖-40℃~+200℃, 更大范围温度请咨询我司。
- The selected material and unique surface treatment contribute strong and reliable connection, increasing performance of the corrosion resistance.
- Various sealing materials are available to all kinds of fluids.
- The applicable temperature range is from -40 C to 200 C according to different O-rings. For wide range of temperature, please consult our company.

**便捷 Convenient**

- 无锁紧结构, 靠外力锁紧。
- 摆动结构或位移结构使轴线不共线的插头插座顺利连接。
- No locking structure, relying on external force locking.
- The floating structure or displacement structure enables the smooth connection of plugs and sockets whose axes are not in the same straight line.

**丰富 Wide range**

- 根据流量大小4种口径任您选择。
- 不同插头插座组合可补偿不同范围对中误差, 最大可达2.4mm。  
(摆动插头与非摆动插座组合最大补偿对中误差为0.25mm; 摆动插头与摆动插座组合最大补偿对中误差为0.5mm; 位移插头与非摆动插座组合最大补偿对中误差为1.2mm; 位移插头和位移插座组合最大补偿误差为2.4mm)。
- 尾部接口形式多样满足您各种需求。
- 口径、接口、颜色均可以根据客户需求定制(各批次间颜色会存在一定差异)。
- 4 different sizes of bores to choose according to flow rate.
- Misalignment tolerance up to 2.4mm according to different combinations of plugs and sockets.  
Floating at one end and installed at another end-misalignment tolerance 0.25mm  
Floating both rnds-misalignment tolerance 0.5mm  
Floating extended to installed socket-misalignment tolerance 1.2mm  
Floating extended to floating extended-misalignment tolerance 2.4mm.
- Various forms of terminations can meet your need.
- Diameter, interface and color can be customized according to customers(color difference could be found between batches).

## 盲插式摆动流体连接器

Floating Blind-Mating fluid connector

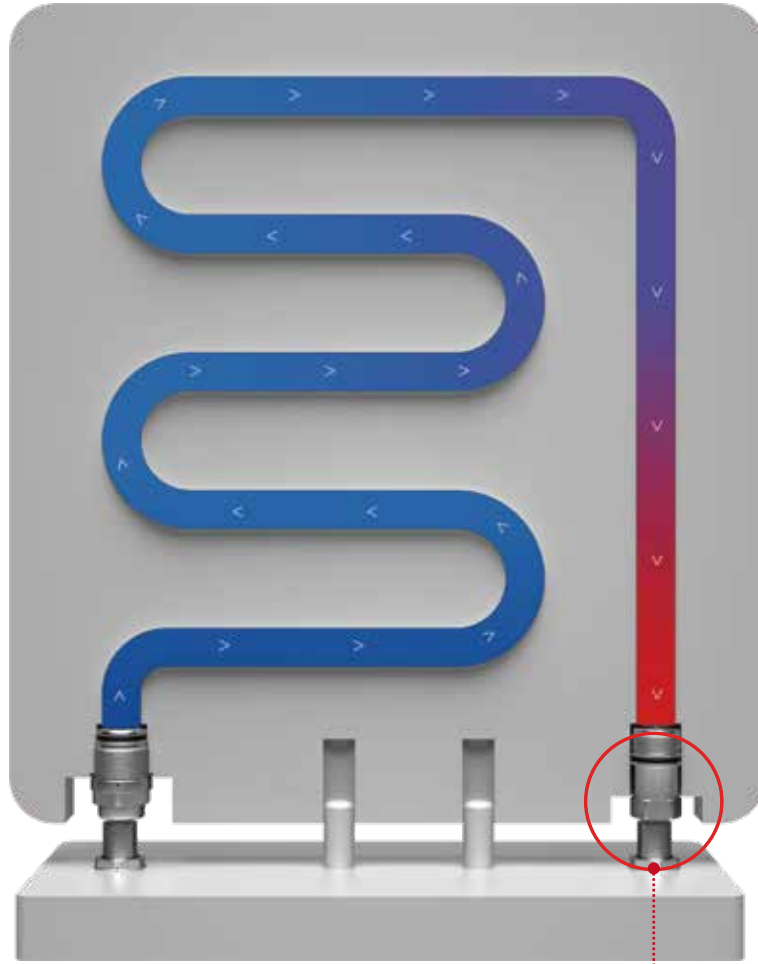

插头、插座皆可摆动，对中误差 $D \leq 0.5\text{mm}$   
Plugs and sockets can float, both ends-misalignment tolerance 0.5 mm

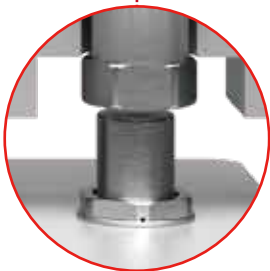

插头可摆动，对中误差 $D \leq 0.25\text{mm}$   
The plugs can float, end-misalignment tolerance 0.25 mm



## 产品命名规则

FBI - 12 P AL E 2M30

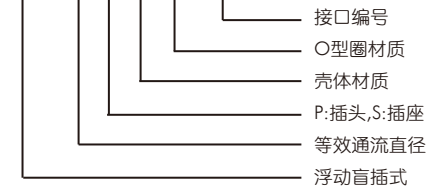

FBIR - 12 P AL E 2M30 - 01

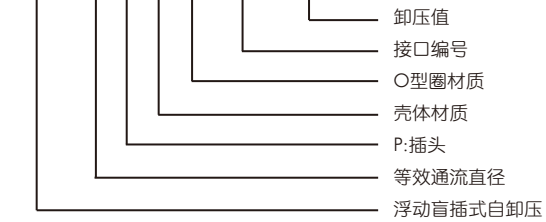

壳体材质	AL:铝; SS:不锈钢; BR:黄铜
O型圈材质	E:EPDM,三元乙丙橡胶,-20℃~+150℃ FV:FVMQ,氟硅橡胶,-40℃~+175℃ FP:FPM,氟碳橡胶, -10℃~+200℃
卸压值	01:卸压值0.2~0.7MPa,即自卸压插座断开时0~0.2MPa密封,卸压压力不大于0.7MPa。 02:卸压值0.8~1.6MPa,即自卸压插座断开时0~0.8MPa密封,卸压压力不大于1.6MPa。
等效通流直径	3:流体有效截面积与直径3mm的圆面积相等 5:流体有效截面积与直径5mm的圆面积相等 8:流体有效截面积与直径8mm的圆面积相等 12:流体有效截面积与直径12mm的圆面积相等

接口编号	
1XXXX	-1:内螺纹,第二位便是螺纹类型(M:公制,G:G型螺纹,J:美制螺纹),后几位为螺纹大小,如1G12。
2XXXX	-2:外螺纹,第二位便是螺纹类型(M:公制,G:G型螺纹,J:美制螺纹),后几位为螺纹大小,如2G12。
3XX	-3:卡箍式,后两位为卡箍最小外径,如319。
4XXXX	-4:法兰式,后几位为孔位尺寸,如43636。
5XXXX	-5:为90°弯角,后几位为螺纹或法兰孔位尺寸,如51G12、53636。
6XXXX	-6:无具体意义,特殊编号,或为定制接口。

## PART NUMBERS

FBI - 12 P AL E 2M30

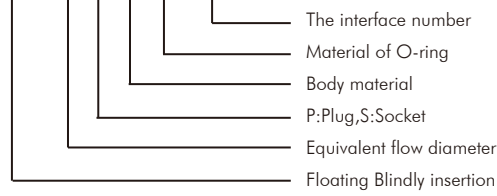

FBIR - 12 P AL E 2M30 - 01

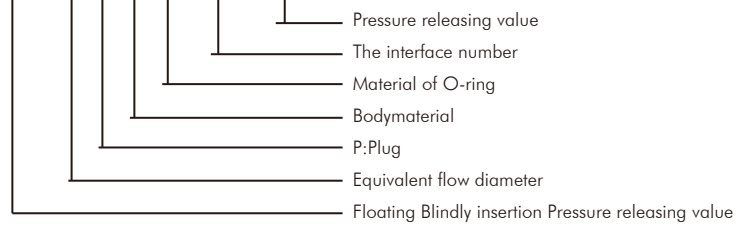

Body material	AL: aluminum; SS: Stainless steel; BR: brass
Material of O-ring	E:EPDM,EPDM rubber,-20 C ~+150 C FV:FVMQ, fluorine silicone rubber,-40 C ~+175 C FP:FPM, fluorocarbon rubber,-10 C ~+200 C
Pressure relief value	01: The pressure releasing value is 0.2~ 0.7Mpa, that is, 0~ 0.2Mpa is sealed when the self-unloading socket is disconnected, and the pressure releasing is not greater than 0.7Mpa. 02: The pressure releasing value is 0.8~ 1.6Mpa, that is, 0~ 0.8Mpa is sealed when the self-unloading socket is disconnected, and the pressure releasing is not greater than 1.6Mpa.
Equivalent flow diameter	3:The effective cross-sectional area of the fluid is equal to the area of a circle with a diameter of 3mm
	5: The effective cross-sectional area of the fluid is equal to the area of a circle with a diameter of 5mm
	8: The effective cross-sectional area of the fluid is equal to the area of a circle with a diameter of 8mm
	12: The effective cross-sectional area of the fluid is equal to the area of a circle with a diameter of 12mm

The interface number	
1XXXX	-1: internal thread, followed by thread type (M: metric, G:G thread, J: American thread), followed by thread size, such as 1G12.
2XXXX	-2: external thread, followed by thread type (M: metric, G:G thread, J: American thread), followed by thread size, such as 2G12.
3XX	-3: clamp, followed by the minimum outer diameter of the clamping, such as 319.
4XXX	-4: Flange, followed by the hole size, such as 43636.
5XXX	-5: right angle, followed by the thread or flange hole size, such as 51G12 53636.
6XXX	-6: customer specific.

## 技术参数

工作温度	-55°C-+95°C	壳体材料种类	黄铜镀镍、铝合金、不锈钢可选
交变湿热	240h	密封件材料种类	丁腈橡胶、三元乙丙橡胶、氟硅橡胶、氟碳橡胶可选
盐雾测试	≥168h	振动测试	按GJB360B-2009方法214, 连接器承受1MPa压力无泄漏
机械寿命	3000次插拔	冲击测试	按GJB360B-2009方法213, 连接器承受1MPa压力无泄漏



### 普通型

产品型号	FBI-3	FBI-5	FBI-8	FBI-12
最大工作压力 (bar)	20	20	20	20
最小爆破压力 (MPa)	6	6	6	6
流量系数 (m³/h)	0.22	0.74	2.0	4.3
最大工作流量 (L/Min)	2.1	5.88	15	33.9
单次插拔最大泄露量 (ml)	0.002	0.005	0.012	0.02
最大插合力 (N)	40	60	90	150



### 自卸压型

产品型号	FBIR-3S	FBIR-5S	FBIR-8S	FBIR-12S
最大工作压力 (bar)	20	20	20	20
流量系数 (m³/h)	0.288	0.747	2.07	4.347
最大工作流量 (L/Min)	2.1	5.88	15	33.9
最大插合力 (N)	40	70	95	160

以上数据仅供参考, 具体参数以产品规格书为准。

### Technical Parameter

Working temperature	-55°C-+95°C	Body material	brass nickel plating, aluminum alloy, stainless steel
Alternating humidity and heat	240h	Sealing material	nitrile rubber, EPDM rubber, fluorosilicone rubber, fluorine-carbon rubber
Salt spray test	≥168h	Vibration test	according to GJB360B-2009 method 214, the connector is subjected to 1MPa pressure without leakage
Mating cycle	3000 times of plugging	Impact test	according to GJB360B-2009 method 213, the connector is subjected to 1MPa pressure without leakage



### Regular Type

Product model	FBI-3	FBI-5	FBI-8	FBI-12
Maximum working pressure (bar)	20	20	20	20
Minimum burst pressure (MPa)	6	6	6	6
Flow coefficient (m³/h)	0.22	0.74	2.0	4.3
Maximum working flow (L/Min)	2.1	5.88	15	33.9
Maximum leakage (ml)	0.002	0.005	0.012	0.02
Maximum insertion force (N)	40	60	90	150



### Pressure Releasing Type

Product model	FBIR-3S	FBIR-5S	FBIR-8S	FBIR-12S
Maximum working pressure (bar)	20	20	20	20
Flow coefficient (m³/h)	0.288	0.747	2.07	4.347
Maximum working flow (L/Min)	2.1	5.88	15	33.9
Maximum insertion force (N)	40	70	95	160

The above parameters are for reference only, the specific parameters shall be subject to the product specifications.

## 浮动盲插式流体连接器对中误差补偿

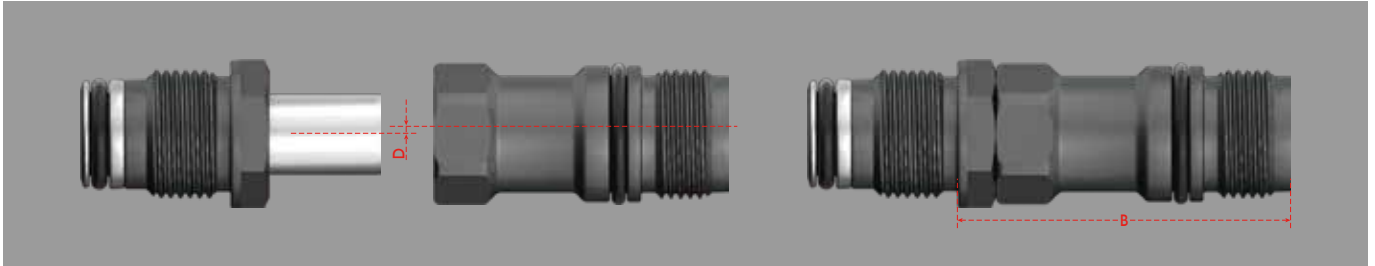

产品型号	最大不对中误差D (mm)	机械限位B (mm)	浮动部分
FBI-3	0.2	26.5±0.3	插头
FBI-5	0.25	41.5±1	插头
FBI-8	0.25	47±1	插头
FBI-12	0.25	63±1	插头



产品型号	最大不对中误差D (mm)	机械限位B (mm)	浮动部分
FBI-5	0.5	21.4±1	插头、插座
FBI-8	0.5	25.5±1	插头、插座
FBI-12	0.5	36±1	插头、插座

以上数据仅供参考，具体参数以产品规格书为准。

### Floating Blind Mate fluid connector compensation for the median error

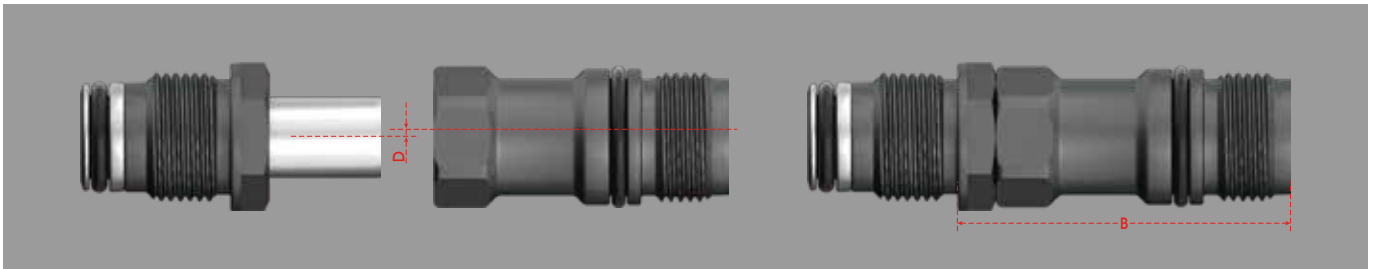

Product model	Maximum mismedian D (mm)	Mechanical limit B (mm)	Floating part
FBI-3	0.2	26.5±0.3	Plugs
FBI-5	0.25	41.5±1	Plugs
FBI-8	0.25	47±1	Plugs
FBI-12	0.25	63±1	Plugs



Product model	Maximum mismedian D (mm)	Mechanical limit B (mm)	Floating part
FBI-5	0.5	21.4±1	Plugs、Sockets
FBI-8	0.5	25.5±1	Plugs、Sockets
FBI-12	0.5	36±1	Plugs、Sockets

The above parameters are for reference only,the specific parameters shall be subject to the product specifications.



### FBI流量曲线

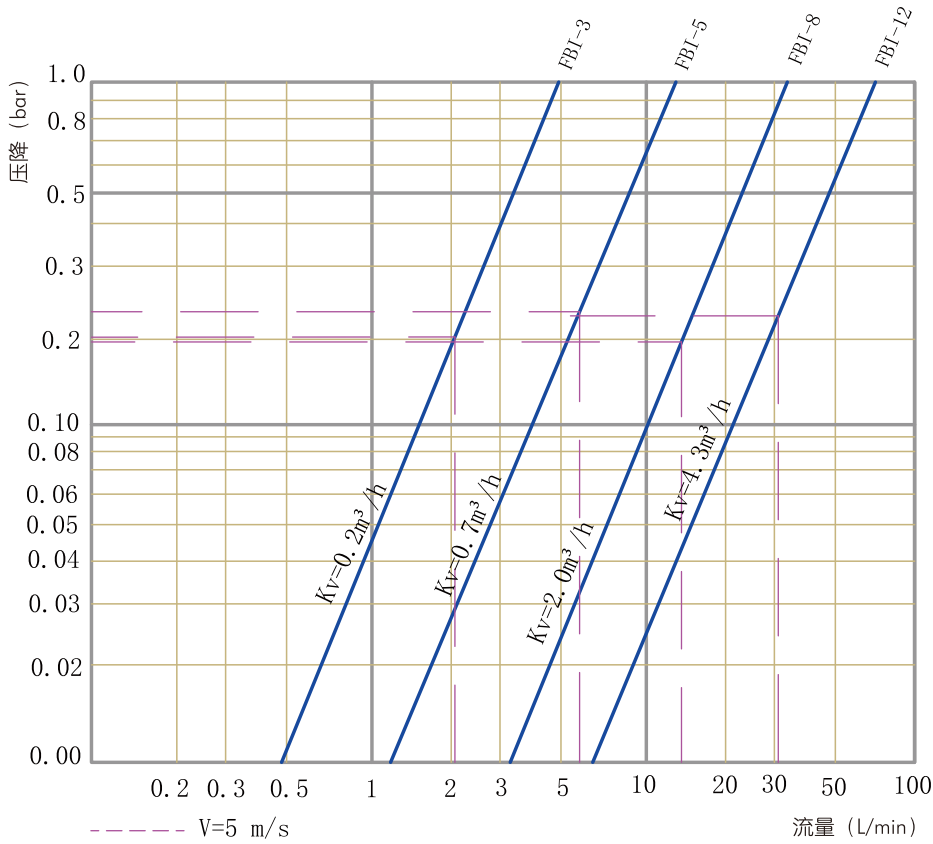

### FBI Flow Chart

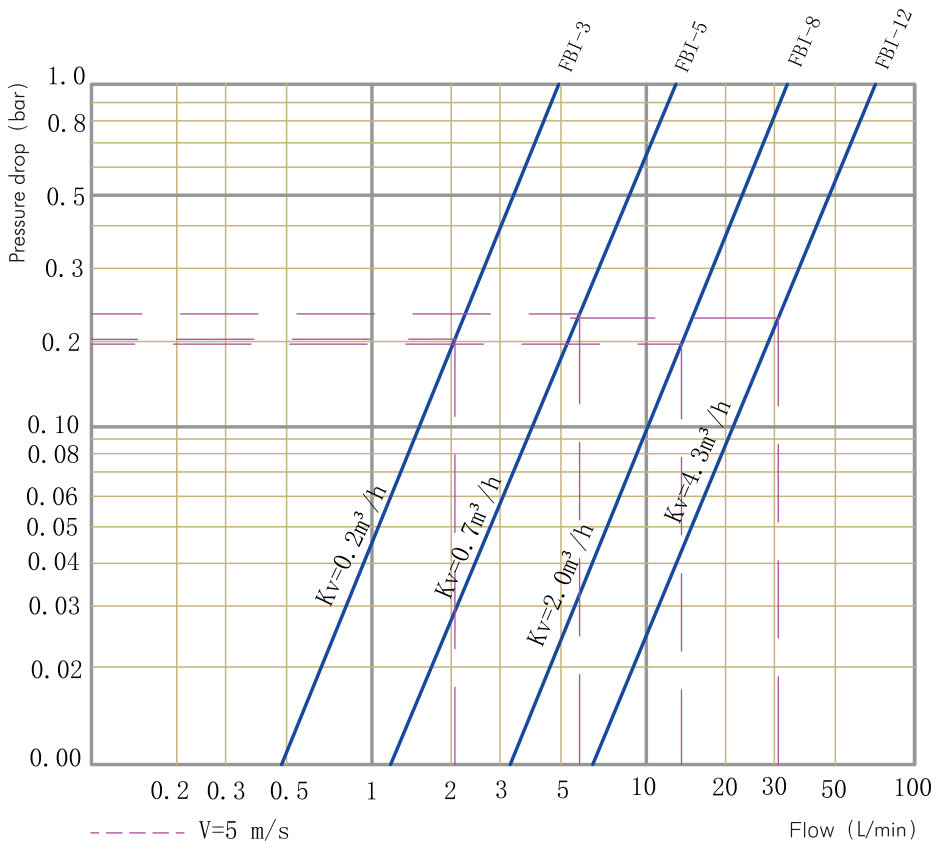

以上数据仅供参考，具体参数以产品规格书为准。The above parameters are for reference only, the specific parameters shall be subject to the product specifications.

→ FBI-3

插头货号 Plug Item No.	插头接口图 Plug interface contour drawing	插头插座连接图 Plug and socket connection diagram	插座接口图 Socket interface contour drawing	插座货号 Socket Item No.
FBI-3PALE2M8				FBI-3SALE2M8
FBI-3PALE2M10				FBI-3SALE2M10

插头货号 Plug Item No.	总长L1 Total length L1 (mm)	接口长度L3 Interface length L3 (mm)	最大直径φD1 Maximum diameter Φ D1 (mm)	接口形式 Interface form	建议开孔尺寸 Suggested opening size
FBI-3PALE2M8	28.8	6.9	10.5	M8X0.75外螺纹	
FBI-3PALE2M10	23.4	11.7	11.5	M10X0.75 外螺纹	

插座货号 Socket Item No.	总长L2 Total length L2 (mm)	接口长度L4 Interface length L4 (mm)	最大直径φD2 Maximum diameter Φ D2 (mm)	接口形式 Interface form	建议开孔尺寸 Suggested opening size
FBI-3SALE2M8	28.1	6.9	10.5	M8X0.75外螺纹	
FBI-3SALE2M10	23	11	11	M10X1外螺纹	

**温馨提示**

**Notes**

1. 以上插头插座可任意组合成套，组合成套货号如：FBI-3PALE2M10+FBI-3SALE2M8。
2. 根据接口形式选择对应货号。
3. 因结构、接口、流体介质不同，流量系数存在差异，流量系数仅供参考。
4. 如需详细尺寸数据，可联系我司技术人员获取。
5. 如无合适接口，可联系我司根据客户特殊定制。

1. The above plugs and sockets can be combined in any way, and the combined article number can be combined in two terms, such as FBI-3PALE2M10+FBI-3SALE2M8.
2. Select the corresponding article number according to the form of interface.
3. Due to different structure, interface and fluid medium, the flow coefficient is different. Flow coefficient is for reference only.
4. For detailed size data, please contact our technical staff to obtain.
5. If there is no appropriate interface, you can contact our company according to the customer's special customization.

以上数据仅供参考，具体参数以产品规格书为准。The above parameters are for reference only, the specific parameters shall be subject to the product specifications.

→ FBI-5



插头货号 Plug Item No.	总长L1 Total length L1 (mm)	接口长度L3 Interface length L3 (mm)	最大直径φD1 Maximum diameter φD1 (mm)	接口形式 Interface form	建议开孔尺寸 Suggested opening size
FBI-5PALE2M16	37.5	16.9	17.6	M16x0.75外螺纹	
FBI-5PALE416.3163	37.5	17.7	—	法兰接口螺丝 孔位16.3x16.3	

插座货号 Socket Item No.	总长L2 Total length L2 (mm)	接口长度L4 Interface length L4 (mm)	最大直径φD2 Maximum diameter φD2 (mm)	接口形式 Interface form	建议开孔尺寸 Suggested opening size
FBI-5SALE2M16	35	18.2	16.5	M16x0.75外螺纹	
FBI-5SALE2M19	35	20	20.5	M19x1外螺纹	
FBI-5SALE42121	36.9	20	—	法兰接口螺丝 孔位21x21	

**温馨提示**

**Notes**

1. 以上插头插座可任意组合成套，组合成套货号如：FBI-5PALE416.316.3+FBI-5SALE2M21。
2. 根据接口形式选择对应货号。
3. 因结构、接口、流体介质不同，流量系数存在差异，流量系数仅供参考。
4. 如需详细尺寸数据，可联系我司技术人员获取。
5. 如无合适接口，可联系我司根据客户特殊定制。

1. The above plugs and sockets can be combined in any way, and the combined article number can be combined in two terms, such as FBI-5PALE416.316.3+FBI-5SALE2M21.
2. Select the corresponding article number according to the form of interface.
3. Due to different structure, interface and fluid medium, the flow coefficient is different. Flow coefficient is for reference only.
4. For detailed size data, please contact our technical staff to obtain.
5. If there is no appropriate interface, you can contact our company according to the customer's special customization.

以上数据仅供参考，具体参数以产品规格书为准。The above parameters are for reference only, the specific parameters shall be subject to the product specifications.

→ FBI-8

插头货号 Plug Item No.	插头接口图 Plug interface contour drawing	插头插座连接图 Plug and socket connection diagram	插座接口图 Socket interface contour drawing	插座货号 Socket Item No.
FBI-8PALE2M21				FBI-8SALE2M21
FBI-8PALE2M22				FBI-8SALE2M22
				FBI-8SALE2M25

插头货号 Plug Item No.	总长L1 Total length L1 (mm)	接口长度L3 Interface length L3 (mm)	最大直径φD1 Maximum diameter Φ D1 (mm)	接口形式 Interface form	建议开孔尺寸 Suggested opening size
FBI-8PALE2M21	38.5	17	23.5	M21x1外螺纹	
FBI-8PALE2M22	38.5	17	23.5	M22x1外螺纹	

插座货号 Socket Item No.	总长L2 Total length L2 (mm)	接口长度L4 Interface length L4 (mm)	最大直径φD2 Maximum diameter Φ D2 (mm)	接口形式 Interface form	建议开孔尺寸 Suggested opening size
FBI-8SALE2M21	38	18	21.5	M21x1外螺纹	
FBI-8SALE2M22	38.5	19	22.5	M22x1外螺纹	
FBI-8SALE2M25	38.5	20.5	27.8	M25x1外螺纹	

**温馨提示**

**Notes**

- 以上插头插座可任意组合成套，组合成套货号如：FBI-8PALE2M21+FBI-8SALE2M25。
- 根据接口形式选择对应货号。
- 因结构、接口、流体介质不同，流量系数存在差异，流量系数仅供参考。
- 如需详细尺寸数据，可联系我司技术人员获取。
- 如无合适接口，可联系我司根据客户特殊定制。

- The above plugs and sockets can be combined in any way, and the combined article number can be combined in two terms, such as FBI-8PALE2M21+FBI-8SALE2M25.
- Select the corresponding article number according to the form of interface.
- Due to different structure, interface and fluid medium, the flow coefficient is different. Flow coefficient is for reference only.
- For detailed size data, please contact our technical staff to obtain.
- If there is no appropriate interface, you can contact our company according to the customer's special customization.

以上数据仅供参考，具体参数以产品规格书为准。The above parameters are for reference only, the specific parameters shall be subject to the product specifications.

→ FBI-12

插头货号 Plug Item No.	插头接口图 Plug interface contour drawing	插头插座连接图 Plug and socket connection diagram	插座接口图 Socket interface contour drawing	插座货号 Socket Item No.
FBI-12PALE2M29				FBI-12SALE2M29
FBI-12PALE2M30				FBI-12SALE2M33
				FBI-12SALE2M36

插头货号 Plug Item No.	总长L1 Total length L1 (mm)	接口长度L3 Interface length L3 (mm)	最大直径φD1 Maximum diameter Φ D1 (mm)	接口形式 Interface form	建议开孔尺寸 Suggested opening size
FBI-12PALE2M29	54	24	31.5	M29x1.5外螺纹	
FBI-12PALE2M30	54	24	34	M30x1外螺纹	

插座货号 Socket Item No.	总长L2 Total length L2 (mm)	接口长度L4 Interface length L4 (mm)	最大直径φD2 Maximum diameter Φ D2 (mm)	接口形式 Interface form	建议开孔尺寸 Suggested opening size
FBI-12SALE2M29	58	25	33	M29x1.5外螺纹	
FBI-12SALE2M33	58	23.7	33.5	M33x1.5外螺纹	
FBI-12SALE2M36	58	27.5	40	M36x1.5外螺纹	

**温馨提示**

**Notes**

- 以上插头插座可任意组合成套，组合成套货号如：FBI-12PALE2M29+FBI-5SALE2M36。
- 根据接口形式选择对应货号。
- 因结构、接口、流体介质不同，流量系数存在差异，流量系数仅供参考。
- 如需详细尺寸数据，可联系我司技术人员获取。
- 如无合适接口，可联系我司根据客户特殊定制。

- The above plugs and sockets can be combined in any way, and the combined article number can be combined in two terms, such as FBI-12PALE2M29+FBI-5SALE2M36.
- Select the corresponding article number according to the form of interface.
- Due to different structure, interface and fluid medium, the flow coefficient is different. Flow coefficient is for reference only.
- For detailed size data, please contact our technical staff to obtain.
- If there is no appropriate interface, you can contact our company according to the customer's special customization.

以上数据仅供参考，具体参数以产品规格书为准。The above parameters are for reference only, the specific parameters shall be subject to the product specifications.

**盲插式位移流体连接器**

Displacement Blind-Mating fluid connector

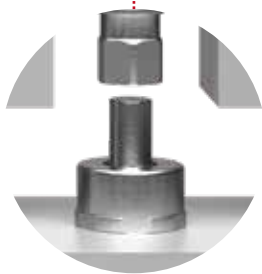
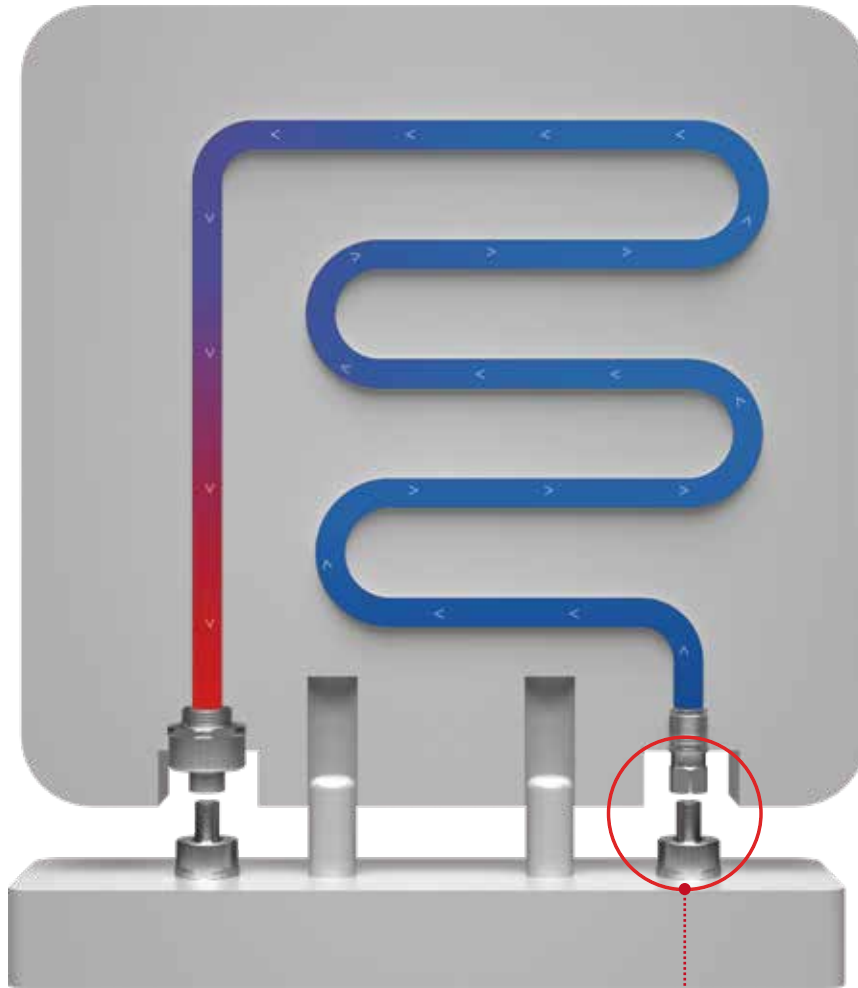

插头位移，对中误差 $D \leq 1.2\text{mm}$   
The plug can be displaced, end-misalignment tolerance 1.2 mm

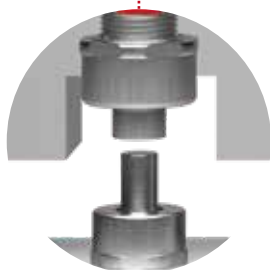

插头插座均位移，对中误差 $D \leq 2.4\text{mm}$   
The plug and socket are displaced, end-misalignment tolerance 2.4 mm



**盲插式位移流体连接器**

Displacement Blind-Mating fluid connector

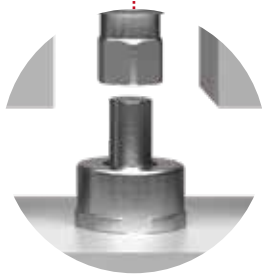
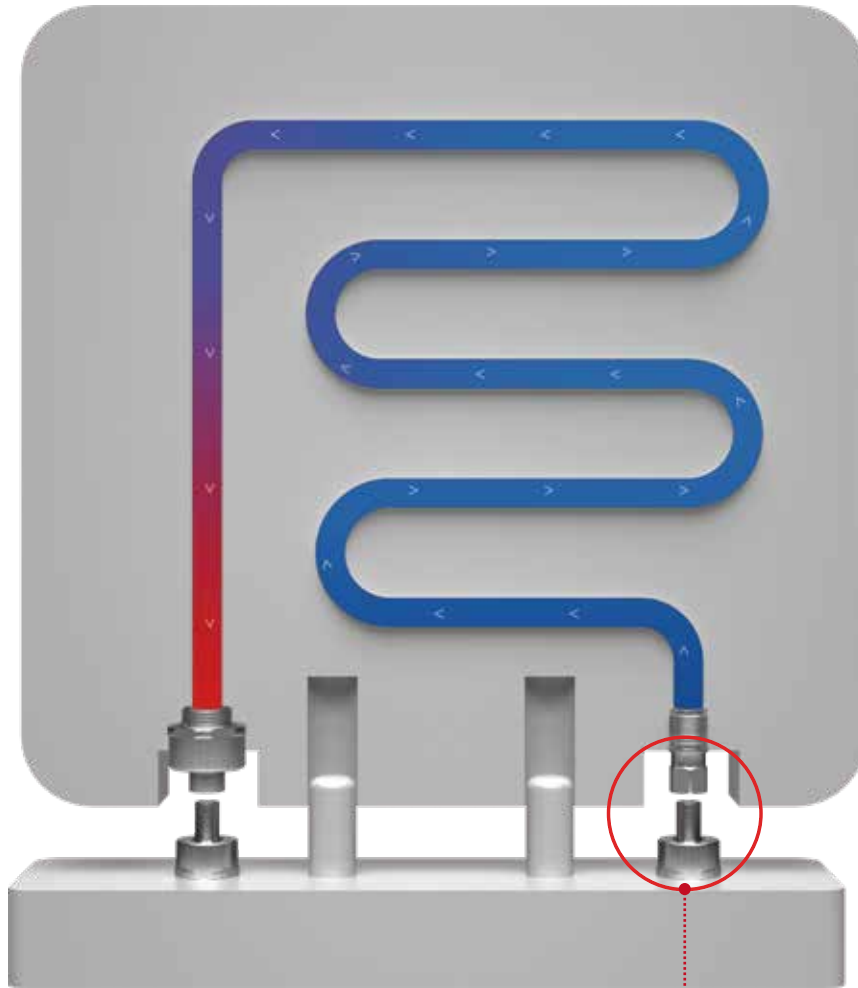

插头位移，对中误差 $D \leq 1.2\text{mm}$   
The plug can be displaced, end-misalignment tolerance 1.2 mm

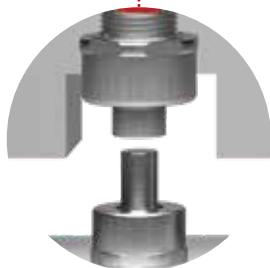

插头插座均位移，对中误差 $D \leq 2.4\text{mm}$   
The plug and socket are displaced, end-misalignment tolerance 2.4 mm

## 产品命名规则

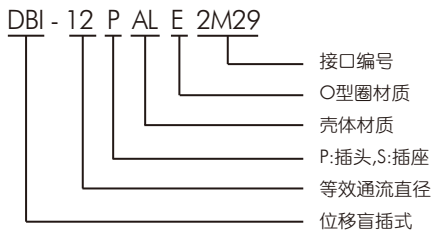

壳体材质	AL:铝； SS:不锈钢； BR:黄铜
O型圈材质	E:EPDM,三元乙丙橡胶,-20℃~+150℃ FV:FVMQ,氟硅橡胶,-40℃~+175℃ FP:FPM,氟碳橡胶, -10℃~+200℃
等效通流直径	3: 流体有效截面积与直径3mm的圆面积相等
	5: 流体有效截面积与直径5mm的圆面积相等
	8: 流体有效截面积与直径8mm的圆面积相等
	12: 流体有效截面积与直径12mm的圆面积相等

接口编号	
1XXXX	-1: 内螺纹, 第二位便是螺纹类型 (M:公制, G:G型螺纹, J:美制螺纹), 后几位为螺纹大小, 如1G12。
2XXXX	-2: 外螺纹, 第二位便是螺纹类型 (M:公制, G:G型螺纹, J:美制螺纹), 后几位为螺纹大小, 如2G12。
3XX	-3: 卡箍式, 后两位为卡箍最小外径, 如319。
4XXXX	-4: 法兰式, 后几位为孔位尺寸, 如43636。
5XXXX	-5: 为90° 弯角, 后几位为螺纹或法兰孔位尺寸, 如51G12、53636。
6XXXX	-6: 无具体意义, 特殊编号, 或为定制接口。

## PART NUMBERS

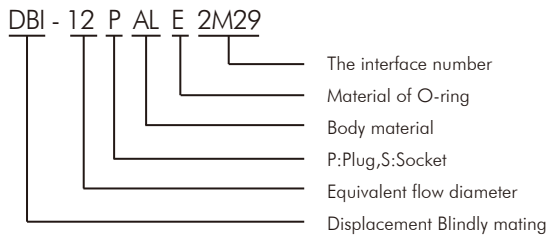

Body material	AL: aluminum; SS: Stainless steel; BR: brass
Material of O-ring	E:EPDM,EPDM rubber,-20 C ~ +150 C    FV: FVMQ, fluorine silicone rubber,-40 C ~ +175 C    FP:FPM, fluorocarbon rubber,-10 C ~ +200 C
Equivalent flow diameter	3: The effective cross-sectional area of the fluid is equal to the area of a circle with a diameter of 3mm
	5: The effective cross-sectional area of the fluid is equal to the area of a circle with a diameter of 5mm
	8: The effective cross-sectional area of the fluid is equal to the area of a circle with a diameter of 8mm
	12: The effective cross-sectional area of the fluid is equal to the area of a circle with a diameter of 12mm

The interface number	
1XXXX	-1: internal thread, followed by thread type (M: metric, G:G thread, J: American thread), followed by thread size, such as 1G12.
2XXXX	-2: external thread, followed by thread type (M: metric, G:G thread, J: American thread), followed by thread size, such as 2G12.
3XX	-3: clamp, followed by the minimum outer diameter of the clamping, such as 319.
4XXXX	-4: Flange, followed by the hole size, such as 43636.
5XXXX	-5: right angle, followed by the thread or flange hole size, such as 51G12 53636.
6XXXX	-6: customer specific.

## 技术参数

工作温度	-55℃-+95℃
交变湿热	240h
盐雾测试	≥168h
机械寿命	3000次插拔
壳体材料种类	黄铜镀镍、铝合金、不锈钢可选
密封件材料种类	丁腈橡胶、三元乙丙橡胶、氟硅橡胶、氟碳橡胶可选
振动测试	按GJB360B-2009方法214, 连接器承受1MPa压力无泄漏
冲击测试	按GJB360B-2009方法213, 连接器承受1MPa压力无泄漏



产品型号	DBI-3	DBI-5	DBI-8	DBI-12
最大工作压力 (bar)	16	16	16	16
最小爆破压力 (MPa)	6	6	6	6
流量系数 (m³/h)	0.25	0.82	2.20	4.81
最大工作流量 (L/Min)	2.1	5.88	15	33.9
单次插拔最大泄露量 (ml)	0.002	0.005	0.012	0.02
最大插合力 (N)	45	60	100	155

## Technical Parameter

Working temperature	-55℃-+95℃	Body material	brass nickel plating, aluminum alloy, stainless steel
Alternating humidity and heat	240h	Sealing material	nitrile rubber, EPDM rubber, fluorosilicone rubber, fluorine-carbon rubber
Salt spray test	≥168h	Vibration test	according to GJB360B-2009 method 214, the connector is subjected to 1MPa pressure without leakage
Mating cycle	3000 times of plugging	Impact test	according to GJB360B-2009 method 213, the connector is subjected to 1MPa pressure without leakage

Product model	DBI-3	DBI-5	DBI-8	DBI-12
Maximum working pressure (bar)	16	16	16	16
Minimum burst pressure (MPa)	6	6	6	6
Flow coefficient (m³/h)	0.25	0.82	2.20	4.81
Maximum working flow (L/Min)	2.1	5.88	15	33.9
Maximum leakage (ml)	0.002	0.005	0.012	0.02
Maximum insertion force (N)	45	60	100	155

以上数据仅供参考，具体参数以产品规格书为准。The above parameters are for reference only, the specific parameters shall be subject to the product specifications.

### 位移盲插式流体连接器对中误差补偿

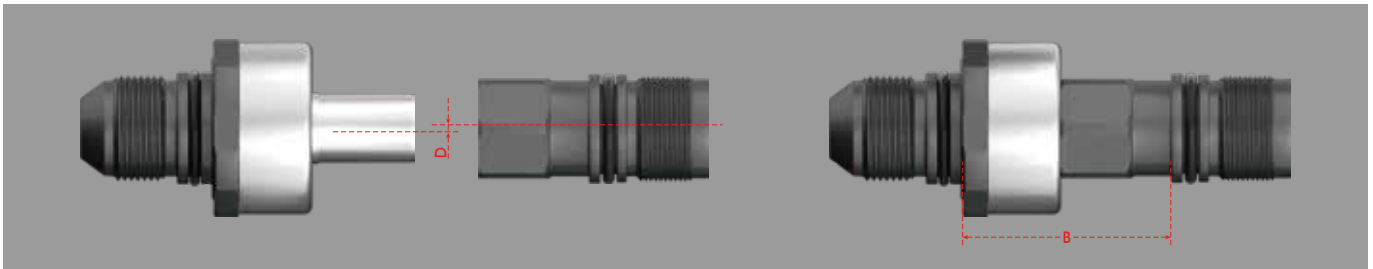

产品型号	最大不对中误差D (mm)	机械限位B (mm)	位移部分
DBI-3	1.2	30±1	插头
DBI-5	1.2	44.5±1	插头
DBI-8	1.2	49±1	插头
DBI-12	1.2	67±1	插头

### Displacement Blind Mate fluid connector compensation for the median error

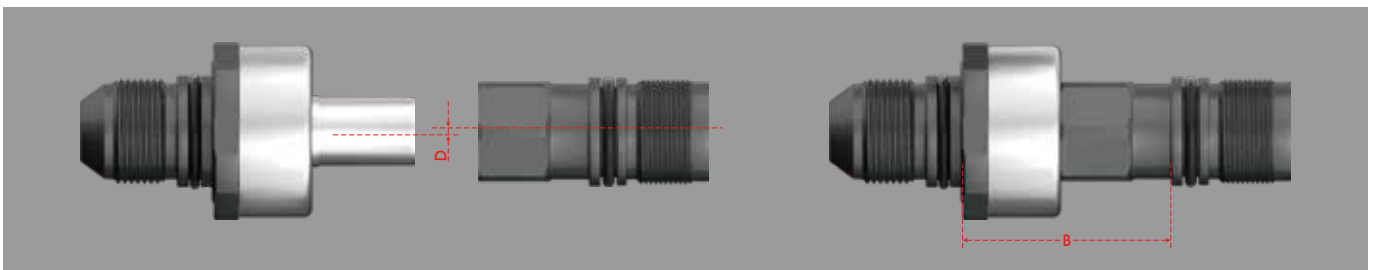

Product model	Maximum mismedian D (mm)	Mechanical limit B (mm)	Displacement part
DBI-3	1.2	30±1	Plugs
DBI-5	1.2	44.5±1	Plugs
DBI-8	1.2	49±1	Plugs
DBI-12	1.2	67±1	Plugs

以上数据仅供参考，具体参数以产品规格书为准。The above parameters are for reference only,the specific parameters shall be subject to the product specifications.

### DBI流量曲线

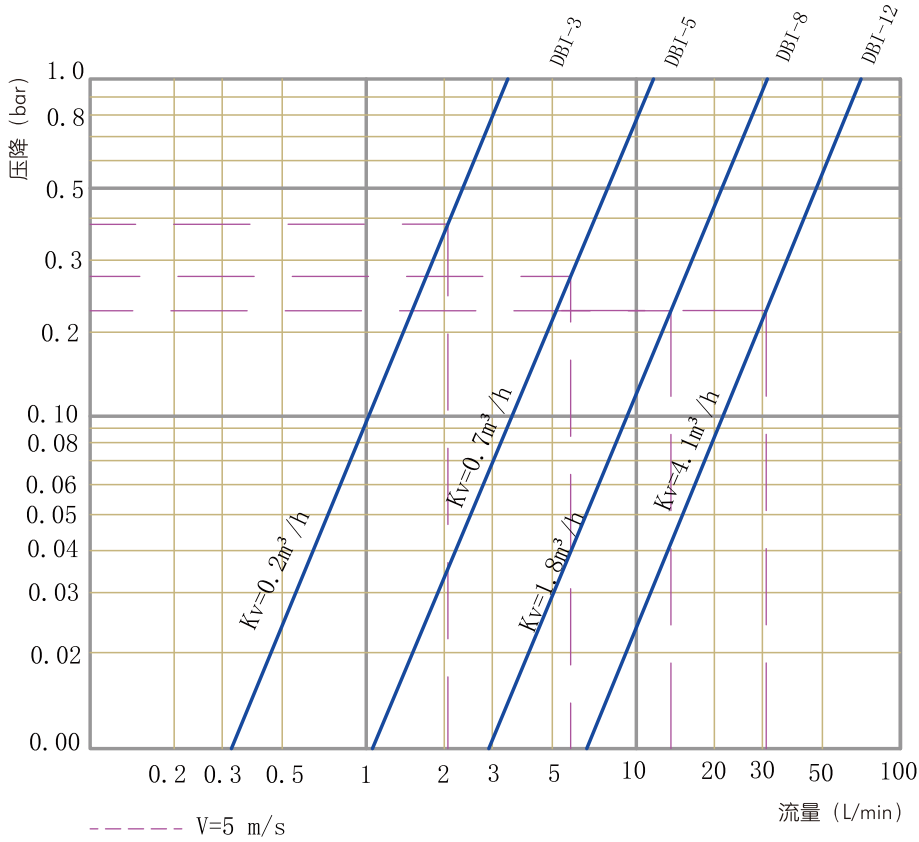

### DBI Flow Chart

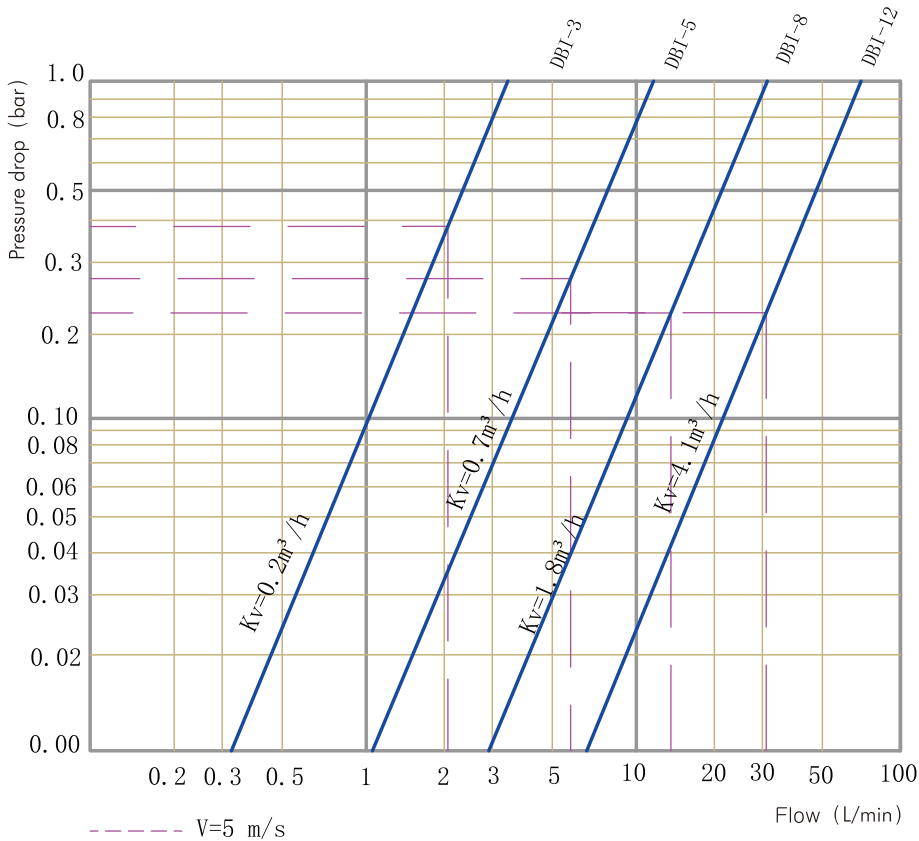

以上数据仅供参考，具体参数以产品规格书为准。The above parameters are for reference only, the specific parameters shall be subject to the product specifications.



接口参数  
Plug contour drawing

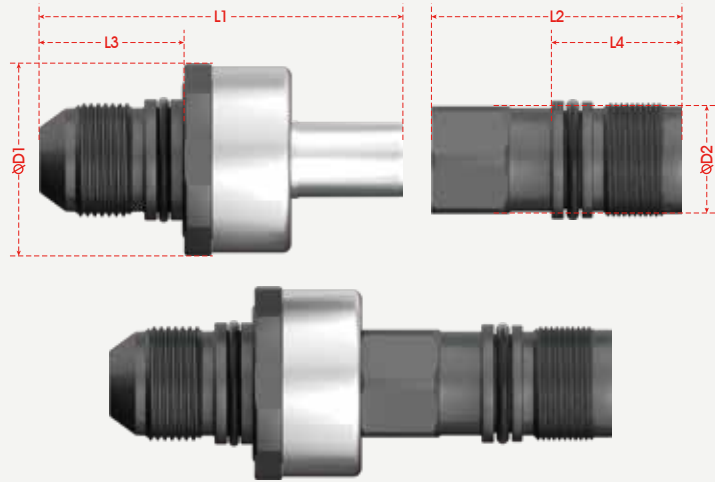

插头货号 Plug Item No.	插头接口编号 Plug interface number	总长L1 Total length L1 (mm)	接口长度L3 Interface length L3 (mm)	最大直径φD1 Maximum diameter φD1 (mm)	接口形式 Interface form
DBI-3PALE2M11	2M11	37.2	11.5	20	M11x1外螺纹
DBI-5PALE2M16	2M16	51.3	13	27.5	M16x0.75外螺纹
DBI-8PALE2M21	2M21	60	16	33	M21x1外螺纹
DBI-12PALE2M29	2M29	73.5	19	41	M29x1.5外螺纹

插座货号 Socket Item No.	插座接口编号 Socket interface number	总长L2 Total length L2 (mm)	接口长度L4 Interface length L4 (mm)	最大直径φD2 Maximum diameter φD2 (mm)	接口形式 Interface form
FBI-3SALE2M10	2M10	23	11	11	M11x1外螺纹
FBI-5SALE2M16	2M16	35	18.2	16.5	M16x0.75外螺纹
FBI-8SALE2M21	2M21	38	18	21.5	M21x1外螺纹
FBI-12SALE2M29	2M29	58	25	33	M29x1.5外螺纹

温馨提示

Notes

1. 以上位移盲插式插头可匹配等直径的浮动盲插式插座，整体(组合、成套)货号可两项相加，如：DBI-3PALE2M11+FBI-3SALE2M8。
2. 根据接口形式选择对应货号。
3. 因结构、接口、流体介质不同，流量系数存在差异，流量系数仅供参考。
4. 如需详细尺寸数据，可联系我司技术人员获取。
5. 如无合适接口，可联系我司根据客户特殊定制。
6. 如需补偿更大对中误差，可联系我司咨询位移盲插式插座。

1. The above plugs can be combined with equal sockets, and the combined article number can be combined in two terms, such as DBI-3PALE2M11+FBI-3SALE2M8.
2. Select the corresponding article number according to the form of interface.
3. Due to different structure, interface and fluid medium, the flow coefficient is different. Flow coefficient is for reference only.
4. For detailed size data, please contact our technical staff to obtain.
5. If there is no appropriate interface, you can contact our company according to the customer's special customization.
6. If you need to compensate for larger pair errors, contact us for displacement blindly insertion sockets.

以上数据仅供参考，具体参数以产品规格书为准。The above parameters are for reference only, the specific parameters shall be subject to the product specifications.

**倍仕得电气科技(杭州)股份有限公司**  
**BEISIT ELECTRIC TECH (HANGZHOU) CO.,LTD.**

浙江杭州余杭经济技术开发区唐梅路1号 邮编：311100

Add.: 1, Tangmei Rd., Yuhang Economic-Technological  
Development Area, Hangzhou, Zhejiang 311100, China

Tel: 0086-571-8936 2888 E-mail: info@beisit.com

Http: // www.beisit.cn Http: // www.beisit.com

**BEISIT GMBH**

Parkstraße 24,65812 Bad Soden am Taunus,Hessen,Germany

Tel:0049-152-2219-5315

E-mail: alex@beisit.com www.beisit.eu



微信公众号



官网